

Effect of Twisted-Tape on Heat Transfer in a Heat Exchanger

Yaser Rostami Arian¹, Fattah Rabiee², Elham Cheraghi³, Reza Aghayari³ and Heydar Maddah^{2*}

¹Oil Industries Commissioning and Operation Company (Oico), Iran.

²Department of Chemistry, Sciences Faculty, Arak Branch, Islamic Azad University, Arak, Iran.

³Fakhr Razi Institute of Higher Education, Saveh, Iran.

Article history

Received: 23rd-May-2015

Revised: 15th-June-2015

Available online: 30th June, 2015

Keywords:

Double pipe heat exchanger,
Nanofluid,
Twisted tape

Abstract

Performance heat transfer and overall heat transfer in a double pipe heat exchanger fitted with twisted-tape elements and pure carbon nanoparticles from pomegranate peel pre-dispersed in water were studied experimentally. The inner and outer diameters of the inner tube were 8 and 16 mm, respectively, and cold and hot water were used as working fluids in shell side and tube side. The twisted tapes were made from aluminum sheet with tape thickness (d) of 1 mm, width (W) of 5 mm, and length of 120 cm. Carbon nanoparticles with a diameter of 10-15nm and a volume concentration of 0.2% (v/v) were prepared. The effects of temperature, mass flow rate, and concentration of nanoparticles on the overall heat transfer coefficient, heat transfer changes in the turbulent and laminar flow regime ($Re \geq 900$), and counter current flow were investigated. When using twisted tape and nanofluid, heat transfer coefficient was about 15 to 30 percent higher than when they were not used. It was also observed that the heat transfer coefficient increases with operating temperature and mass flow rate. The experimental results also showed that 0.2% carbon /water nanofluid with twisted tape has slightly higher friction factor and pressure drop when compared to 0.2% carbon nanoparticles /water nanofluid without twisted tape. The empirical correlations proposed for friction factor are in good agreement with the experimental data.

© 2015 JMSSE All rights reserved

Introduction

The addition of solid particles into heat transfer media has long been known as one of the useful techniques for enhancing heat transfer, although a major consideration when using suspended millimetre-or micrometer-sized particles is that they have the potential to cause some severe problems, such as abrasion, clogging, high pressure drop, and sedimentation of particles. Compared to heat transfer enhancement through the use of suspended large particles, the use of nanoparticles in the fluids exhibited better properties relating to the heat transfer of fluid. This is because nanoparticles are usually used at very low concentrations and nanometre sizes. These properties prevent the sedimentation in the flow that may clog the channel. From these points of view, there have been some previous studies conducted on the heat transfer of nanoparticles in suspension. Since Choi et al. wrote the first review article on nanofluids.

Maddah et al [1] investigate synthesis and thermo-physical properties including thermal conductivity and viscosity of Fe_3O_4 Nanofluid. In this study, Fe_3O_4 nanoparticles with the size of 20 nm were prepared. The nanoparticles was characterized by X-ray powder diffraction (XRD) analysis and transmission electron microscopy (TEM). Additionally, the effect of many parameters on the Fe_3O_4 nanoparticles was studied. The thermal conductivity and viscosity of nanofluids are measured and it is found that the viscosity increase is substantially higher than the increase in thermal conductivity. All of the property thermal conductivity, electrical conductivity and viscosity of nanofluids increase with the nanoparticle volume concentration. Theoretical models are developed to predict thermal conductivity and viscosity of nanofluids without resorting to the well established Maxwell and

Einstein models, respectively. The proposed models show reasonably good agreement with our experimental results.

Maddah et al [2] describes experimental and theoretical aspects of the effective thermal conductivity, electrical conductivity, and viscosity of nanofluids. The thermal conductivity, electrical conductivity, and viscosity of nanofluids increase with the nanoparticle volume fraction. The nanofluid was prepared by synthesizing Al_2O_3 and Ag nanoparticles using microwave-assisted chemical precipitation method and then dispersed in distilled water using a sonicator. Water nanofluid with nominal diameters of 20 and 40 nm at various volume concentrations (0.25% to 5%) at a temperature of 15°C was used for the investigation. The thermal conductivity, electrical conductivity, and viscosity of nanofluids were measured, and it was found that the viscosity and electrical conductivity increase is substantially higher than the increase in thermal conductivity. The pure base fluid thermal conductivity displayed a Newtonian behavior at 15°C; it transformed to a non-Newtonian fluid with the addition of a small amount of nanoparticles $\phi > 3\%$.

Aghayari et al [3] Heat transfer and overall heat transfer in a double pipe heat exchanger fitted with twisted-tape elements and titanium dioxide nanofluid were studied experimentally. The inner and outer diameters of the inner tube were 8 and 16 mm, respectively, and cold and hot water were used as working fluids in shell side and tube side. The twisted tapes were made from aluminum sheet with tape thickness (d) of 1 mm, width (W) of 5 mm, and length of 120 cm. Titanium dioxide nanoparticles with a diameter of 30nm and a volume concentration of 0.01% (v/v) were prepared. The effects of temperature, mass flow rate, and concentration of nanoparticles on the overall heat transfer

coefficient, heat transfer changes in the turbulent flow regime ($Re \geq 2300$), and counter current flow were investigated. When using twisted tape and nanofluid, heat transfer coefficient was about 10 to 25 percent higher than when they were not used. It was also observed that the heat transfer coefficient increases with operating temperature and mass flow rate. The experimental results also showed that 0.01% TiO₂/water nanofluid with twisted tape has slightly higher friction factor and pressure drop when compared to 0.01% TiO₂/water nanofluid without twisted tape. The empirical correlations proposed for friction factor are in good agreement with the experimental data.

Aghayari et al [4] reports experimentally the convection heat transfer coefficient and Nusselt number of the Fe₃O₄-water nanofluids flowing in a double pipe heat exchanger under turbulent flow ($14000 \leq Re \leq 34600$) conditions. Fe₃O₄ nanoparticles with diameters of 15-20 nm dispersed in water with volume concentrations of $0.08 \leq \phi \leq 0.1$ vol. % are used as the test fluid. The results show that the convection heat transfer coefficient and Nusselt number of nanofluid was approximately 12 -26% greater than that of pure fluid. In addition, the heat transfer coefficients and Nusselt number increases with increase in flow rate, nanoparticle concentration and nanofluid temperature. Comparison of experimental results with valid theoretical data based on semi-empirical equations shows an acceptable agreement.

Maddah et al[5] physical behavior of the thermal and fluid flow of the Al₂O₃ Nanofluid in a horizontal double pipe counter-flow heat exchanger fitted with modified twisted tapes were experimentally studied under turbulent flow conditions. The experiments with and without typical twisted tapes and nanofluid were performed under similar operation condition and validated with existing well established correlations to verify experimental setup. Al₂O₃ nanoparticles with diameters of 21 nm dispersed in water and the concentration was varied from 0.2 to 0.9% by volume. The nanofluid considered as non-Newtonian fluid due to the shear-thinning rheological behavior. The mathematical concept of Geometrical Progression was applied to prepare modified twisted tapes. Pitch length of the proposed twisted tapes and consequently the twist ratios changed along the twists with respect to the Geometrical Progression Ratio (GPR) whether reducer (RGPR < 1) or increaser (IGPR > 1). The experiments were performed using modified tapes with seven different Geometrical Progression Ratios (RGPR = 0.6, 0.75 and 0.85, typical twist with GPR=1, IGPR = 1.2, 1.5 and 2) over a Reynolds number range of 5000 to 21000. Regarding the experimental data, utilization of RGPR twists together with nanofluids tend to increase heat transfer and friction factor by 12% to 52% and 5% to 28% as compared with the tube with the typical twisted tapes (GPR=1) and nanofluid. Contrarily, performances were weakened by using for IGPR twists 0.6 to 0.92 and 0.75 to 0.95 times of those in the typical twisted tapes and nanofluid. Over the range investigated, heat transfer rates were enhanced in term of Nusselt numbers by the RGPR twisted tape with nanofluid up to 4 and with IGPR twists up to 1.84 times of that in the plain tube. Based on the same pumping power consumption, the thermal performances of the heat exchanger with nanofluid and modified twisted tapes were evaluated for the assessment of overall improvement in thermal behavior. Generalized correlations were developed for the estimation of Nusselt number, friction factor and thermal performance factor under turbulent flow conditions. Satisfactory agreement between the present correlations and obtained experimental data validate the proposed correlations.

Experimental

Experimental setup

The nanofluid used in the experiment was +99.0% pure carbon nanoparticles from pomegranate peel predispersed in water, with an average particle size of 15-20 nm. The nanofluid was mixed with deionized water. To prepare experimental concentrations, nanofluids with less than 3% nanoparticles were found to be stable and the stability lasted over a week; no intermediate mixing was considered necessary. The volume fraction of carbon nanoparticles from pomegranate peel nano-particles in nanofluid sample varied from 0.2% v/v. NF samples were then underwent mixing by ultrasonic method between 3 to 4 hours to ensure complete dispersion is achieved. The morphology of carbon nanoparticles from pomegranate peel nano-particles was studied by using SEM. (Figure 1a,b)

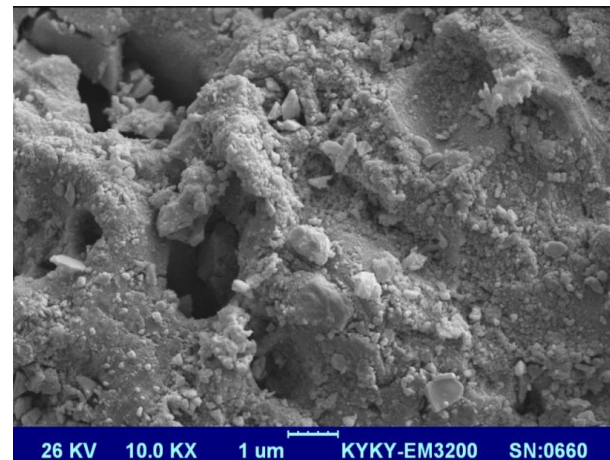

(a)

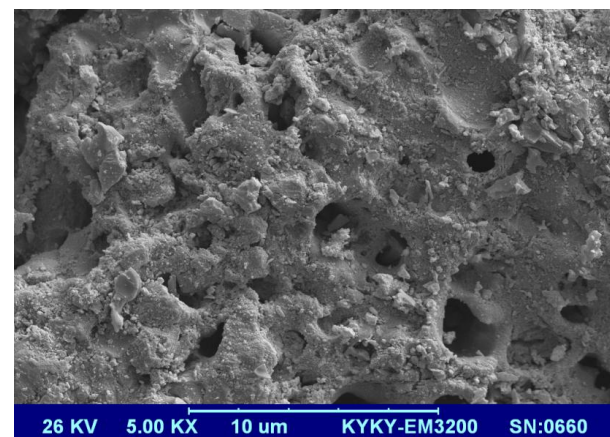

(b)

Figure 1: (a,b) SEM photographs of carbon nanoparticles from pomegranate peel particles.

Heat transfer Experimental set-up and procedure

The experimental investigation of heat transfer characteristic of nanofluid was carried out using the experimental apparatus as shown in Figures 2 and 3. It mainly consists of a test section, receiving tanks in which working fluids are stored, heating and cooling system, thermometer, flow meter, rotameter, pressure measurement system, and data acquisition system.

The working fluids were circulated through the loop by using variable speed pumps of suitable capacity. The test section is of 1.2m length with counter flow path within horizontal double pipe heat exchanger in which hot nanofluid was applied inside the tube while cooling water was directed through the annulus. The inside pipe is made of a soft steel tube with the inner diameter of 6 mm,

outer diameter of 8 mm, and thickness of 2mm while the outside pipe is of steel tube with the inner diameter of 14 mm, outer diameter of 16 mm, and thickness of 2 mm. The twisted tapes were made from aluminum sheet with tape thickness (d) of 1 mm, width (W) of 5mm, and length of 120cm. The tape thickness of 1mm was chosen to avoid an additional friction in the system that might occur by the thicker tape. To produce the modified twisted tape, the typical twists changed by changing twist ratio and geometrical progression ratio along the twist (Figure 3). To measure the inlet and outlet temperature of the nanofluid and cold water at the inlet and outlet of the test section, 4 thermocouples of type J were used. All of the thermocouples were calibrated before fixing them. All four evaluated temperature probes were connected to the data logger sets. Another data logger with 4 thermocouples which of the thermocouples were taped along the inner tube wall at equally space to measure the circumferential temperature variation All four evaluated temperature probes were connected to the data logger sets. An electric heater and a thermostat installed on it were used to maintain the temperature of the nanofluid. During the test, the mass flow rate and the inlet and outlet temperatures of the nanofluid and cold water were measured.

To measure the pressure drop across the test section, differential pressure transmitter was mounted at the pressure tab located at the inlet and outlet of the section. The nanofluid flow rate was measured by a magnetic flow meter which was placed at the entrance of the test section. For each test run, it was essential to record the data of the temperature volumetric flow rates, and pressure drop across the section at steady state conditions. Two storage tanks made of stainless steel at capacity of 15 lit were used to collect the fluids leaving the test section. Hot nanofluid was pumped from the fluid tank through the inner tube included twisted tapes at different Reynolds number between 800 and 28000. To ensure the steady state condition for each run, the period of around 15–20 minutes depending on Reynolds number and twisted tapes was taken prior to the data record.

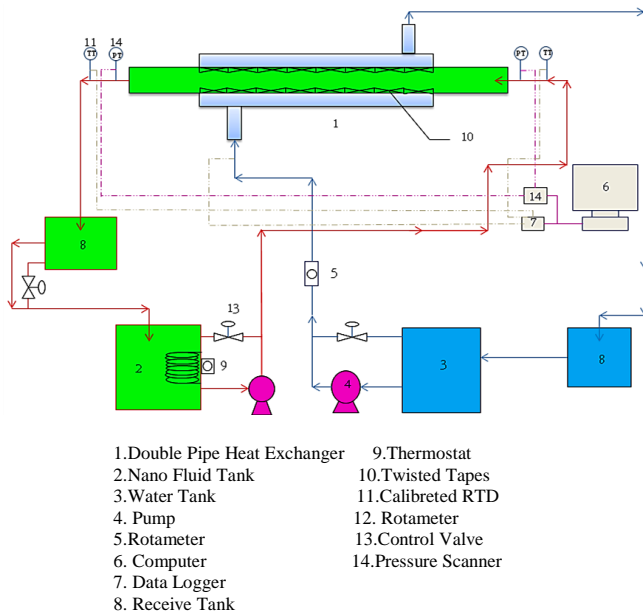

Figure 2: Schematic diagram of the experimental setup[3].

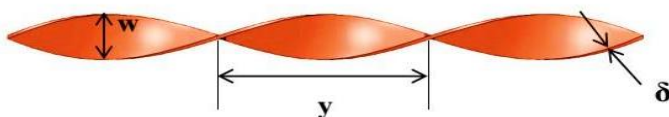

Figure 3: Geometries of typical twisted tape

Data reduction

In the present study, the carbon nanoparticles dispersed in water with volume concentrations of 0.2 % v/v. During the test, cold water absorbed heat from hot nanofluid. The heat transfer rate from the heating fluid was calculated from the following equation:

$$Q_{nf} = \dot{m}_{nf} C_{p_{nf}} (T_{out} - T_{in})_{nf} \tag{1}$$

where Q_{nf} is the heat transfer rate of the nanofluid and \dot{m}_{nf} is the mass flow rate of the nanofluid. The heat transfer rate into the cooling water was calculated from the following equation:

$$Q_w = \dot{m}_w C_{p_w} (T_{out} - T_{in})_w \tag{2}$$

In this study, the supplied heat by the hot nanofluid was found to be 3% higher than the received heat. This deviation can be interpreted by convection and radiation heat loss along the test section. The average heat transfer rate is:

$$Q_{ave} = \frac{Q_w + Q_{nf}}{2} \tag{3}$$

The average value of experimental heat transfer coefficient and mean Nusselt number of the nanofluid are evaluated as the following:

$$h_{nf} = \frac{q_{ave}}{\bar{T}_{wall} - T_{b,nf}} \tag{4}$$

$$Nu_{nf} = \frac{h_{nf} D}{K_{nf}} \tag{5}$$

Where \bar{T}_{wall} is the mean wall surface temperatures measured by 4 stations lined between the inlet and outlet of the test tube.

$$\bar{T}_{wall} = \sum \frac{T_{wall}}{4} \tag{6}$$

In which T_{wall} is the local wall temperature. $T_{b,nf}$ is mean bulk nanofluid temperature :

$$T_{b,nf} = \frac{T_{in} + T_{out}}{2} \tag{7}$$

The flow regime can be defined from Reynolds number based on the flow rate at the inlet of the test tube. For purely viscous non-Newtonian fluid, the Reynolds number is defined as follows:

$$Re = \frac{\rho_{nf} v_{nf}^{2-n} d_i^n}{m \gamma^{n-1}} \tag{8}$$

Where v_{nf} is the mean velocity of the nanofluid and d_i diameter of the tube.

Friction factor can be calculated from the following equation:

$$f_{nf} = \frac{\Delta P_{nf}}{(L/d_i) \rho_{nf} (v_{nf}^2/2)} \tag{9}$$

where f_{nf} is the friction factor of the nanofluid, ΔP_{nf} is the measured pressure drop of the nanofluid and L is the length of the tube.

The Prandtl number and Peclet number of the nanofluid can be evaluated from the following equations:

$$Pr_{nf} = \frac{m \gamma^{n-1} C_{p_{nf}}}{K_{nf}} \tag{10}$$

$$Pe_{nf} = \frac{v_{nf} d_p}{\alpha_{nf}} \tag{11}$$

Where d_p is the diameter of the nanoparticles and α_{nf} is the thermal diffusivity of the nanofluid.

The performance evaluation analysis (η) is defined as the enhanced convective heat transfer coefficient (h_E) to the non-enhanced one (h_{NE}) at the same pumping power.

$$\eta = \frac{h_E}{h_{NE}} \tag{12}$$

$$Nu = Nu_0 \cdot \left(1 + \frac{52Gr}{pr}\right)^{0.28} \tag{13}$$

To compare friction factor, Blasius correlation [6] for water and Duangthongsuk and Wongwises correlation [7] for nanofluid were employed:

Blasius correlation:

$$f = 0.316Re^{-0.25} \tag{14}$$

and Duangthongsuk and Wongwises correlation:

$$f_{nf} = 0.961\phi^{0.052} Re_{nf}^{-0.375} \tag{15}$$

Results and Discussion

When using carbon NF (nanofluid) as hot fluid, the heat transfer rate and overall heat transfer increases as opposed to that of water, that is base fluid. This finding is depicted in Figures 4 and 5 where, at Reynolds number equal to 28000, the mean HT (heat transfer) rate values for water at 35°C are approximated to 1400 and 2280 Watts, respectively. As for NF 0.2% (v/v) at identical Reynolds number the mean HT rate and overall heat transfer values at the above noted temperatures are 1500 and 2560 Watts, respectively. The heat transfer rate is higher for the twist tape set than the plain tube, because of strong swirl flow in the twist tape. Due to the tangential velocity component and smaller flow cross-sectional area, the mixing of fluid between fluid at the wall region and fluid at the core region, induced by the generated centrifugal force, has significant ability to enhance heat transfer rate. The values of overall heat transfer coefficient of the nanofluid as compared to those of the base fluid in both laminar and turbulent regimes are higher. One explanation can be the affecting parameters including Reynolds numbers for the hot and cold fluid, the size of nanoparticles, the type of heat exchanger, and NF temperature. It is evident that the friction factor continues to decrease with Reynolds number. As expected, the friction factor obtained from the tube with twisted-tape insert is significantly higher than that without twisted-tape insert. flow is one of the main parameters in determining the performance of the nanofluid as the hot fluid. In calculating the pressure drop, the density, viscosity, and friction factor of the fluid must be taken into consideration. When using a fluid with high density and viscosity, this pressure drop increases. Therefore, this is one of the disadvantages of using nanofluid as the heat transfer fluid. For example, Figure 6 represents the obtained values of the friction factor for water at the temperature of 35°C. Then, these results are compared with the Blasius theoretical model. As expected, the results are in good agreement with the theoretical model.

As seen in Figures 7, when using nanofluid, the friction factor was slightly higher than in the base fluid. With the simultaneous use of nanofluid and twisted tape, this amount increases.

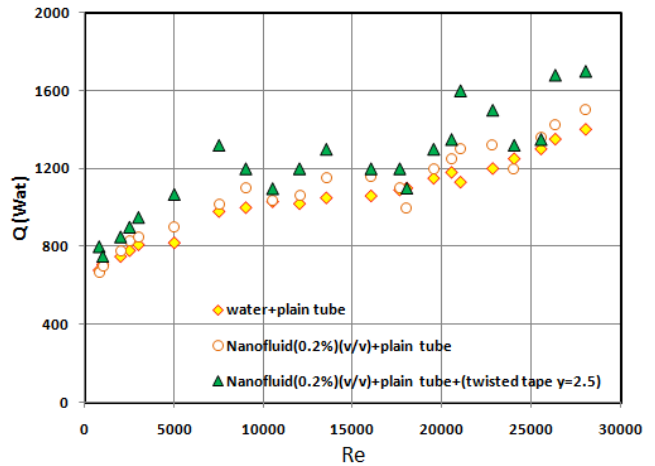

Figure 4: Variation of mean heat flow rate with Reynolds number

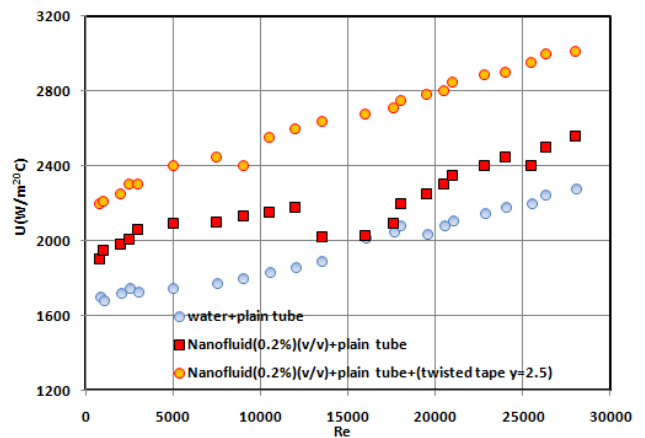

Figure 5: Variation of overall heat transfer coefficient with Reynolds number.

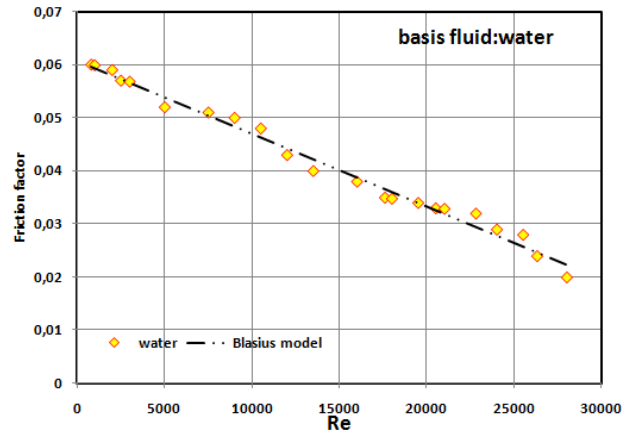

Figure 6: Comparison between measured friction factor and that calculated from Blasius equation [6].

It can be said that using nanofluid without twisted tape and with twisted tape increases the friction factor to 1.2 % as compared to the base fluid. Since the friction factor is in direct relation to the pressure drop, the pressure drop increases. The obtained values are in good agreement with Duangthongsuk and Wongwises theoretical model. The uncertainties for the nanofluid without and with the twisted tape are 2 and 2.5% as compared to Duangthongsuk and Wongwises theoretical model. As seen in Figure 8, thermal efficiency is higher when using the nanofluid

with twisted tape than when only nanofluid or water is used. The minimum and maximum increase are 10 to 30%.

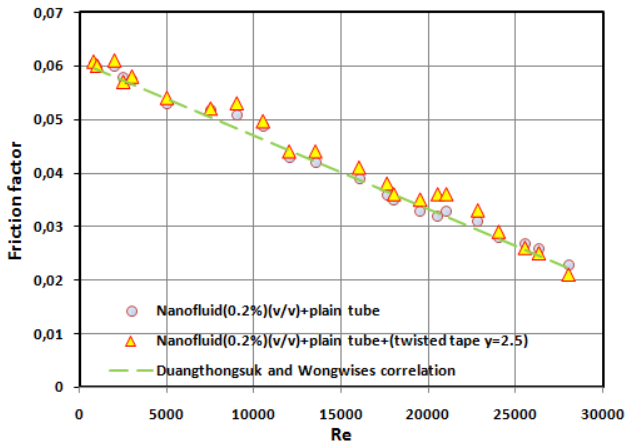

Figure 7: Comparison between measured friction factor and that calculated from Duangthongsuk and Wongwises correlation [7].

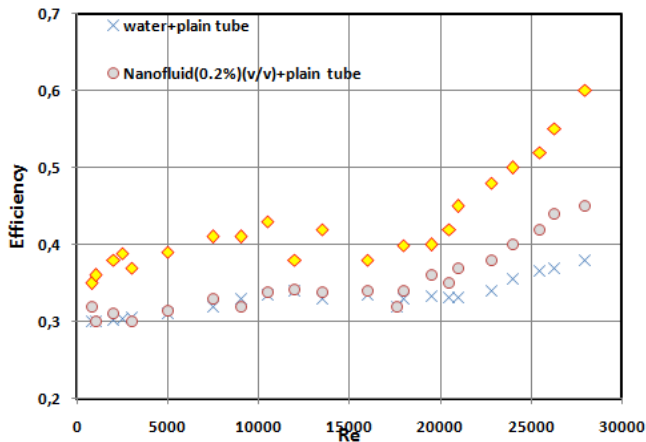

Figure 8: The effect of volume concentration and twisted-tape carbon-water on the efficiency at different Reynolds numbers.

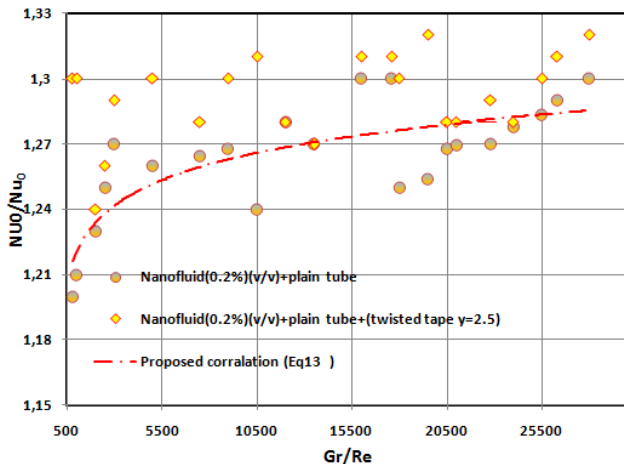

Figure 9: Relation between Experimental Data & Analytical Data For Vertical Tube.

As seen in Figure 9, a good agreement between experimental data and model there.

Conclusions

Experimental results obtained with the carbon nanofluid heat exchanger and twisted tape with the pitch of 2.5 can be summarized as follows.

1. Using carbon nanofluid with the volume concentration of 0.2% in the double pipe heat exchanger with the twisted tape and without the twist tape increases the heat transfer and overall heat transfer coefficient about 10% and 32% as compared to the base fluid.
2. Using carbon nanofluid with the volume concentration of 0.2% in the double pipe heat exchanger with the twisted tape and without the twist tape increases the friction factor about 1.2% and 3% as compared to the base fluid.
3. Results show that Blasius and Duangthongsuk and Wongwises theoretical models are in good agreement with the experimental data related to the friction factor and the observed uncertainty is low.

References

1. H. Maddah et al, Synthesis and Thermo-physical Properties of Fe₂O₃ Nanofluid, Journal of Materials Science & Surface Engineering Vol. 2 (1), 2015, pp 109-113.
2. H. Maddah et al, The effect of silver and aluminum oxide nanoparticles on thermophysical properties of nanofluids, Journal Of Nanostructure in Chemistry, May 2013, 3:28, DOI: 10.1186/2193-8865-3-28.
3. R. Aghayari, Effect of Twisted-Tape Turbulators and Nanofluid on Heat Transfer in a Double Pipe Heat Exchanger, Journal of Engineering Volume 2014, Article ID 920970, 9 pages. DOI:10.1155/2014/920970.
4. R. Aghayari et al, Heat Transfer of Iron Oxide Nanofluid in a Double Pipe Heat Exchanger, Journal of Materials Science & Surface Engineering Vol. 2 (1), 2015, pp 84-89.
5. H. Maddah et al, Experimental Study of AL₂O₃/Water Nanofluid Turbulent Heat Transfer Enhancement in the Horizontal Double Pipes fitted with Modified Twisted Tapes, International Journal of Heat and Mass Transfer 78 (2014) 1042–1054.
6. R. B. Bird, W. E. Stewart, and E. N. Lightfoot, Transport Phenomena, JohnWiley & Sons, 2nd edition, 2002.
7. W. Duangthongsuk and S. Wongwises, “An experimental study on the heat transfer performance and pressure drop of TiO₂ water nanofluids flowing under a turbulent flow regime,” International Journal of Heat and Mass Transfer, vol. 53, no. 1–3, pp. 334–344, 2010.

